

18" FF FLANGE
 150 lb ANSI
 STANDARD
 BOLT PATTERN

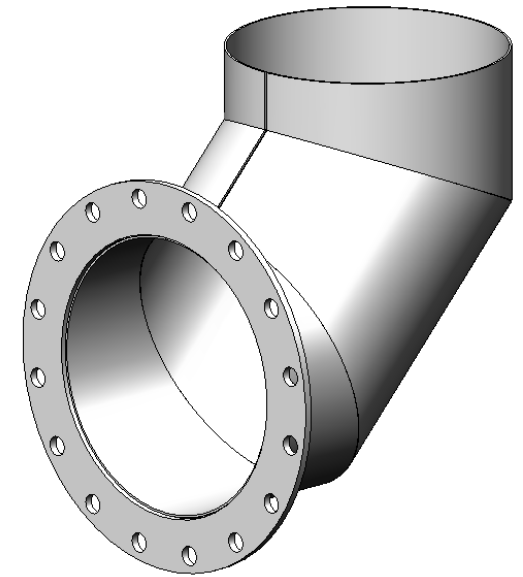
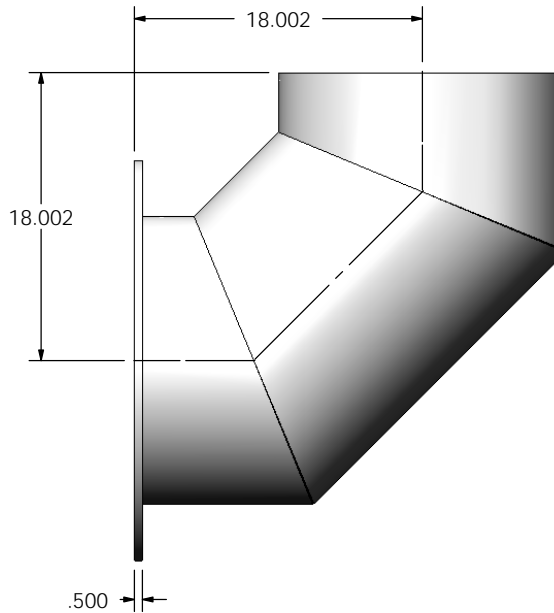

NOTES:

- DO NOT USE EQUIPMENT TO SUPPORT OTHER PARTS OF THE EXHAUST SYSTEM WITHOUT PROPER REINFORCEMENT

MATERIAL CONSTRUCTION:

- CARBON STEEL

PAINT:



- HIGH TEMPERATURE BLACK (MIRATECH COATING SYSTEM 5)

PROJECT NAME
PROPOSAL NUMBER
SALES ORDER NO.
CUSTOMER P.O.

PROPRIETARY AND CONFIDENTIAL

THE INFORMATION CONTAINED IN THIS DRAWING IS THE SOLE PROPERTY OF MIRATECH GROUP, LLC. ANY REPRODUCTION IN PART OR AS A WHOLE WITHOUT THE WRITTEN PERMISSION OF MIRATECH GROUP, LLC IS PROHIBITED.

DIMENSIONS ARE IN INCHES UNLESS OTHERWISE SPECIFIED	
DIMENSIONAL TOLERANCES UNLESS OTHERWISE SPECIFIED	
ANGLES:	
MACH: $\pm 1^*$	INCHES: ± 0.125
BEND: $\pm 3^*$	MILLIMETERS: ± 2
DO NOT SCALE DRAWING	
DRAWN	DATE
CSF	11/28/2016
REVIEWED BY	DATE
AJM	11/28/2016

 	
EL-18PF1-18PS-180X0180-2 Sales Drawing	
DRAWING	REV
EL-18PF1-18PS-180X0180-2 SD	0
SIZE	SHEET 1 OF 1
A	SCALE 1:12 WEIGHT: 92 lb