

EXHAUST FLOW

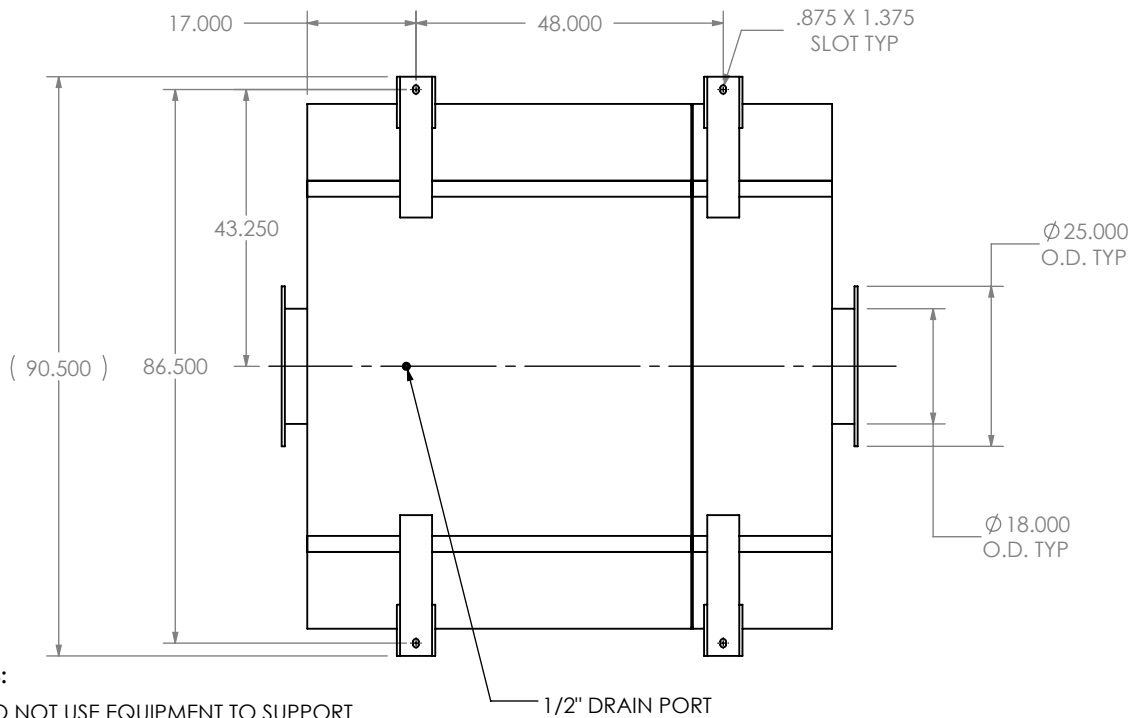
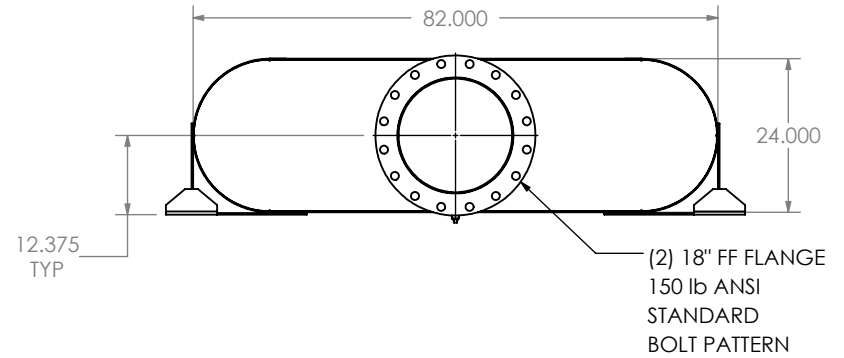

NOTES:

- DO NOT USE EQUIPMENT TO SUPPORT OTHER PARTS OF THE EXHAUST SYSTEM WITHOUT PROPER REINFORCEMENT

MATERIAL CONSTRUCTION:

- 304 STAINLESS STEEL

PAINT:

- NONE

PROJECT NAME	
PROPOSAL NUMBER	
SALES ORDER NO.	
CUSTOMER P.O.	

PROPRIETARY AND CONFIDENTIAL

THE INFORMATION CONTAINED IN THIS DRAWING IS THE SOLE PROPERTY OF MIRATECH GROUP, LLC. ANY REPRODUCTION IN PART OR AS A WHOLE WITHOUT THE WRITTEN PERMISSION OF MIRATECH GROUP, LLC IS PROHIBITED.

DIMENSIONS ARE IN INCHES UNLESS OTHERWISE SPECIFIED

DIMENSIONAL TOLERANCES UNLESS OTHERWISE SPECIFIED	
ANGLES:	
MACH: ±1°	INCHES: ±0.125
BEND: ±3°	MILLIMETERS: ±2

DO NOT SCALE DRAWING

DRAWN	DATE
FES	9/16/2016
REVIEWED BY	DATE
AJM	09/30/2016

OCEE0B-18PF-3-00000000 Sales Drawing			
DRAWING		OCEE0B-18PF-3-00000000 SD	
REV	0	SCALE	1:30
SIZE	A	WEIGHT	1221 lb
		SHEET 1 OF 1	